

ROTATOR GR55FF

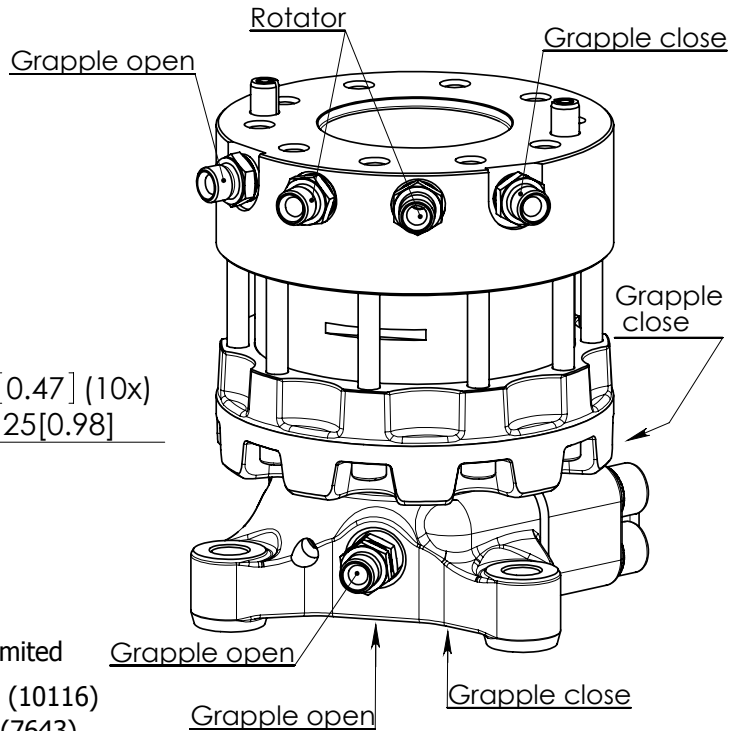
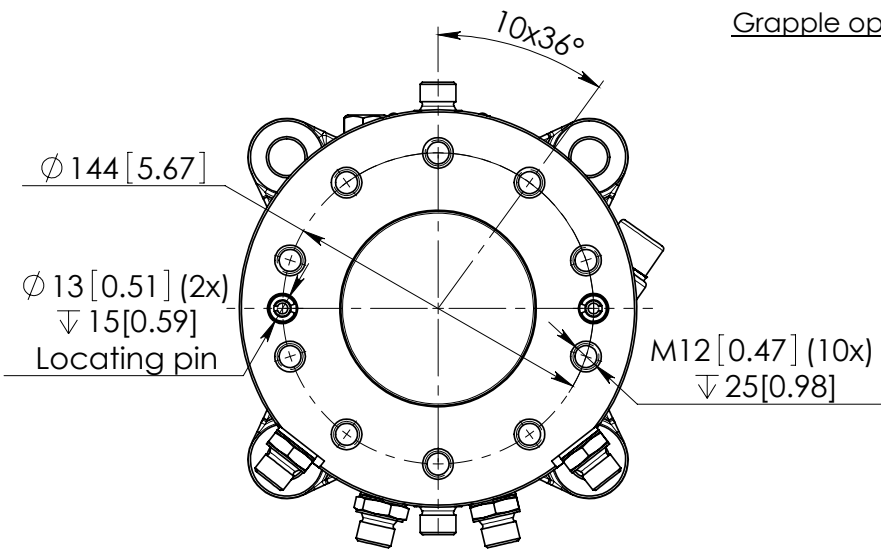
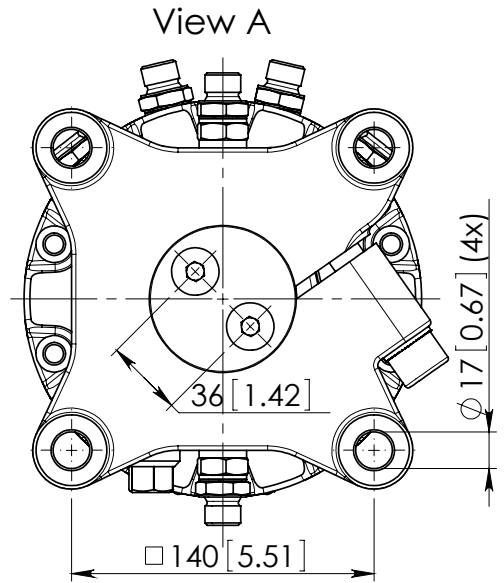
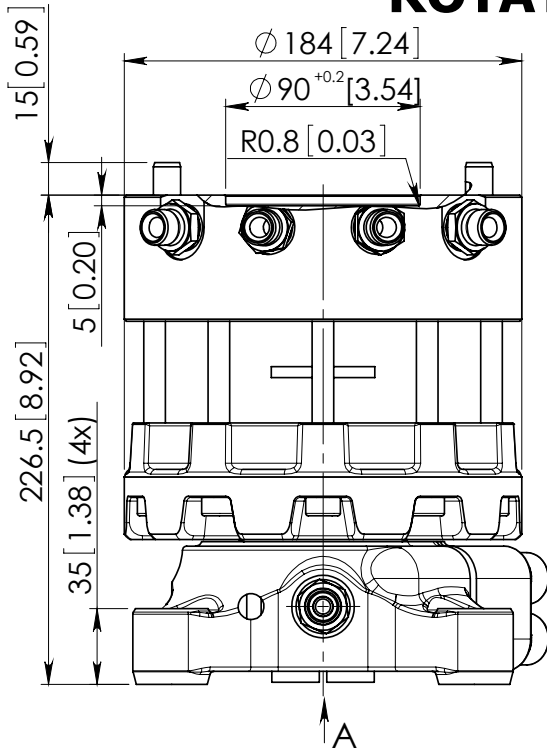

Technical data

Rotation	Unlimited
Max axial load static, KN (lbf)	+45 (10116) -34 (7643)
Max axial load dynamic, KN (lbf)	+25 (5620) -17 (3821)
Torque at 25Mpa (3625psi), Nm (lb ft)	1300 (959)
Rec oilflow, l/min (US gallon)	22 (5.8)
Weight, kg (lb)	35 (78)

Max working pressure:

Rotator	←R→	Max 25 MPa (3625 psi)	G 3/8"
Grapple / Tool open	←G→	Max 20 MPa (2900 psi)	G 3/8"
Grapple / Tool close	→G←	Max 30 MPa (4350 psi)	G 3/8"

Connection: